

Color and Finish Codes

NTGRX-2B-SL-__-__
2-Button with Status Light Wallstation

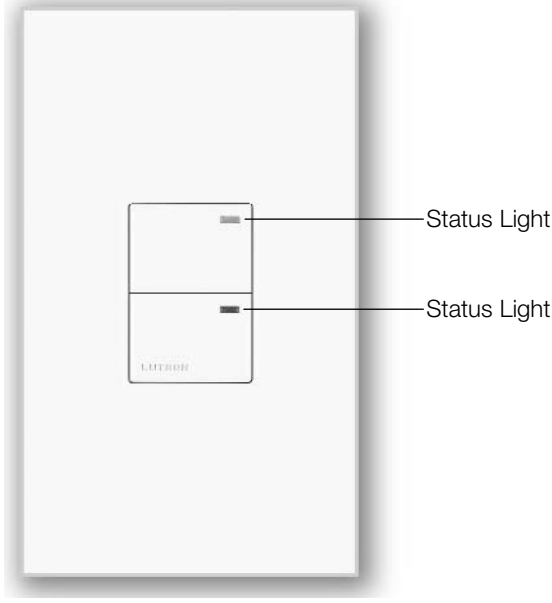







Description

- Often used in entryways to turn lights on and off.
- Functionality can be selected in the field.
- Status lights indicate which button was pushed last.
- Works with GRAFIK Eye 3000 and 4000 Series Control Units.
- Invokes functions in just one Control Unit or group of up to eight Control Units.

Finish and Engraving Options

Available with engraving to meet specific project needs.

Field Selected Functionality

	DIP Switch Settings	Top button:	Bottom button:
	5 6 7		
Entrance Wallstation		Selects scene 1.	Turns lights off.
Scene Selection		Selects scene 9. Selects scene 13.	Selects scene 10. Selects scene 14.
Panic Wallstation		Selects scene 16 (all lighting full on). Locks all other system controls.	Restores previous scene. Disables lockout.
Fine Tuning		Temporarily brightens selected zones.	Temporarily dims selected zones.
Single-Partition Status Wallstation		Control Units act in combination; movable wall open to make one large space.	Control Units act independently; movable wall closed to make two spaces.
Zone Lockout		Allows only temporary zone adjustment. Preset scene settings are not affected.	Disables zone lockout.
Sequencing		Loops continuously through scenes 5 to 16 using fade times entered at Control Units.	Turns sequencing off.

Job Name:	Model Numbers:
Job Number:	

Color and Finish Codes

NTGRX-KS-__-__
Keyswitch Wallstation









Description

- Ideal for public spaces.
- Limits access to GRAFIK Eye Control Units. Authorized personnel must use a key to adjust lighting.
- Functionality can be selected in the field.
- Works with GRAFIK Eye 3000 and 4000 Series Control Units.
- Invokes functions in just one Control Unit or a group of up to eight Control Units.

Finish and Engraving Options

Available with engraving to meet specific project needs.

Field Selected Functionality

	DIP Switch Settings	Turning key clockwise:	Turning key counter-clockwise:
	5 6 7		
Entrance Wallstation		Selects scene 1.	Turns lights off.
Scene Selection		Selects scene 9. Selects scene 13.	Selects scene 10. Selects scene 14.
Panic Wallstation		Selects scene 16 (all lighting full on). Locks all other system controls.	Restores previous scene. Disables lockout.
Fine Tuning		Temporarily brightens selected zones.	Temporarily dims selected zones.
Single-Partition Status Wallstation		Control Units act in combination; movable wall open to make one large space.	Control Units act independently; movable wall closed to make two spaces.
Zone Lockout		Allows only temporary zone adjustment. Preset scene settings are not affected.	Disables zone lockout.
Sequencing		Loops continuously through scenes 5 to 16 using fade times entered at Control Units.	Turns sequencing off.

Job Name:	Model Numbers:
Job Number:	

Color and Finish Codes

NTGRX-4B-__-__
4-Button Wallstation

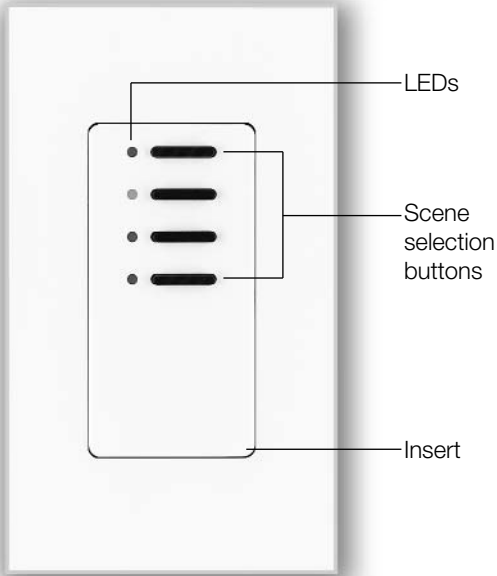





Description

- Used to select scenes in GRAFIK Eye Control Units.
- Scene selection functionality can be selected in the field.
- Status LEDs indicate which scene is selected.
- Works with GRAFIK Eye 3000 and 4000 Series Control Units.
- Selects scenes in just one Control Unit or a group of up to eight Control Units.
- Can be ganged with the NTGRX-4S Wallstation to give occupants access to 8, 12, or 16 scenes.

Finish and Engraving Options

- Available with engraving to meet specific project needs.
- Available in a “no-insert” version for a sleeker look.

Field Selected Functionality

DIP Switch Settings	Scene selection buttons activate:
5 6	
	Scenes 1 to 4
	Scenes 5 to 8
	Scenes 9 to 12
	Scenes 13 to 16

Job Name:	Model Numbers:
Job Number:	

Color and Finish Codes

NTGRX-4S-__-__
4-Scene with Off and Raise/Lower
Wallstation

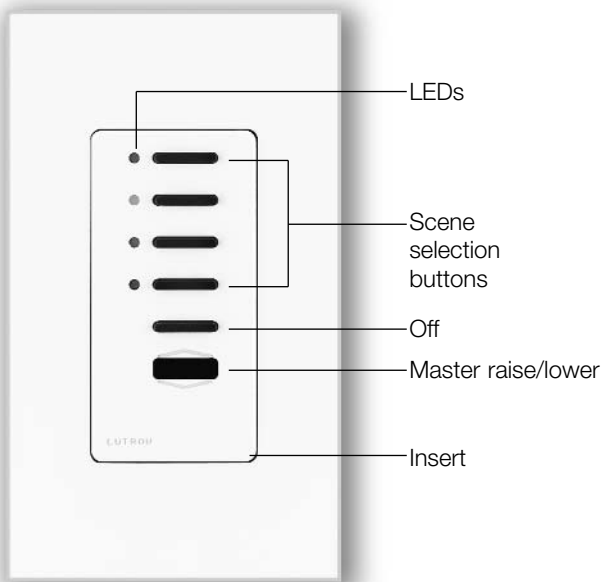





Description

- Used to select and adjust scenes in GRAFIK Eye Control Units.
- Scene selection functionality can be selected in the field.
- Status LEDs indicate which scene is selected.
- Off button turns all lights off.
- Master raise/lower button brightens or dims all lighting in the selected scene.
- Works with GRAFIK Eye 3000 and 4000 Series Control Units.
- Selects scenes in just one Control Unit or a group of up to eight Control Units.

Finish and Engraving Options

- Available with engraving to meet specific project needs.
- Available in a “no-insert” version for a sleeker look.

Field Selected Functionality

DIP Switch Settings	Scene selection buttons activate:
5 6	
	Scenes 1 to 4
	Scenes 5 to 8
	Scenes 9 to 12
	Scenes 13 to 16

Job Name:	Model Numbers:
Job Number:	

Color and Finish Codes

NTGRX-4S-IR-__ - __
4-Scene with Off and IR Receiver
Wallstation

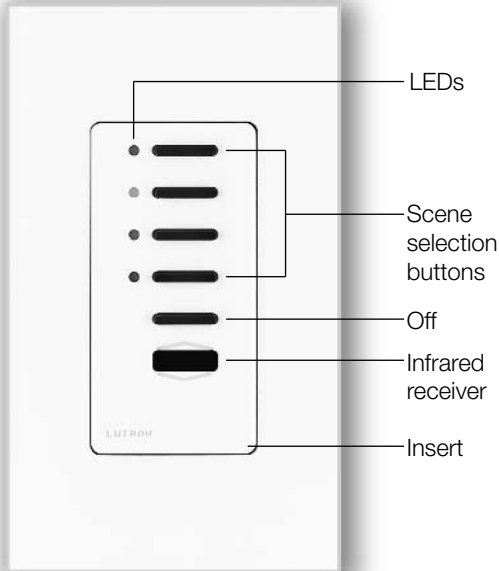





Description

- Allows user to select scenes at the Wallstation or by Wireless Remote Control.
- Scene selection functionality can be selected in the field.
- Status LEDs indicate which scene is selected.
- Off button turns all lights off.
- Infrared receiver allows infrared transmitters to select scenes and raise/lower lighting zones.
- Raise/lower button on GRX-IT and GRX-8IT Wireless Remote Controls brightens or dims all lighting in the selected scene.
- Works with GRAFIK Eye 3000 and 4000 Series Control Units.
- Selects scenes in just one Control Unit or a group of up to eight Control Units.

Finish and Engraving Options

- Available with engraving to meet specific project needs.
- Available in a “no-insert” version for a sleeker look.

Field Selected Functionality

DIP Switch Settings	Scene selection buttons and GRX-IT 4-Scene Wireless Remote Control activates:	GRX-IT 8-Scene Wireless Remote Control activates:
5 6		
	Scenes 1 to 4	Scenes 1 to 8
	Scenes 5 to 8	Scenes 5 to 12
	Scenes 9 to 12	Scenes 9 to 16
	Scenes 13 to 16	Scenes 13 to 16/1 to 4

Job Name:	Model Numbers:
Job Number:	

Color and Finish Codes

NTGRX-SI4S-IR-__-__
Switch Interface, 4-Scene with Off,
and IR Receiver Wallstation

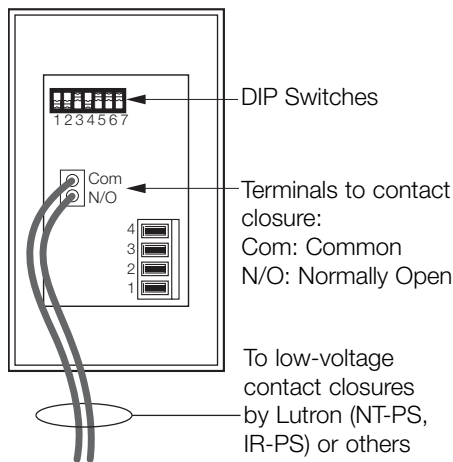
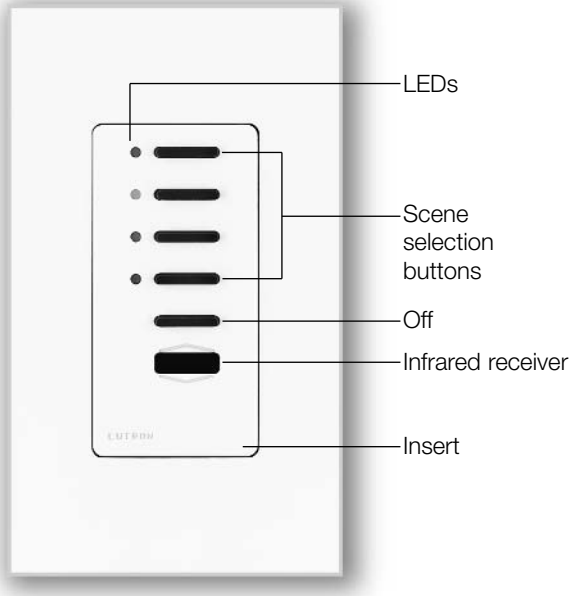

Description

- Ideal for partitionable spaces. Allows user to access different sets of scenes depending on whether partition wall is open or closed.
- Terminals on the back of the Wallstation connect to a contact closure such as a switch on a movable wall.
- Scene selection functionality can be selected in the field.
- Occupants can also select scenes using a GRX-IT Wireless Remote Control.
- Status LEDs indicate which scene is selected.
- Off button turns all lights off.
- Raise/lower button on GRX-IT Wireless Remote Control brightens or dims all lighting in the selected scene.
- Works with GRAFIK Eye 3000 and 4000 Series Control Units.
- Selects scenes in just one Control Unit or a group of up to eight Control Units. (Locate the Control Units away from the usable space so occupants must control lighting from the Wallstation.)

Contact Closure Specifications

- Maintained dry contact closure only - 15mA minimum.
- Terminals accept one #18 AWG (1.0mm²) standard wire.

Finish and Engraving Options

- Available with engraving to meet specific project needs.
- Available in a “no-insert” version for a sleeker look.

Field Selected Functionality

DIP Switch Settings	When contact is OPEN, scene selection buttons and GRX-IT select:	When contact is CLOSED, scene selection buttons and GRX-IT select:
5 6		
	Scenes 1 to 4	Scenes 1 to 4
	Scenes 5 to 8	Scenes 1 to 4
	Scenes 9 to 12	Scenes 9 to 12
	Scenes 13 to 16	Scenes 9 to 12

Job Name:	Model Numbers:
Job Number:	

Color and Finish Codes

NTGRX-4PS-__-__
4-Partition Status Wallstation

Description

- Coordinates lighting for up to four movable walls (five rooms). Each toggle button is set up to operate the Control Units associated with a movable wall.
- When the wall is open to make one large space, the user presses the wall's toggle button to make the LED light up. The GRAFIK Eye Control Units assigned to the buttons now work "in combination." Scene changes at one Control Unit occur on all of these Control Units.
- When the wall is closed to make several smaller spaces, the user presses the wall's toggle button to turn off the LED. The Control Units now work independently.
- The bottom button resets all Control Units to independent operation.
- The example shows how to use the Wallstation for a space with four movable walls.

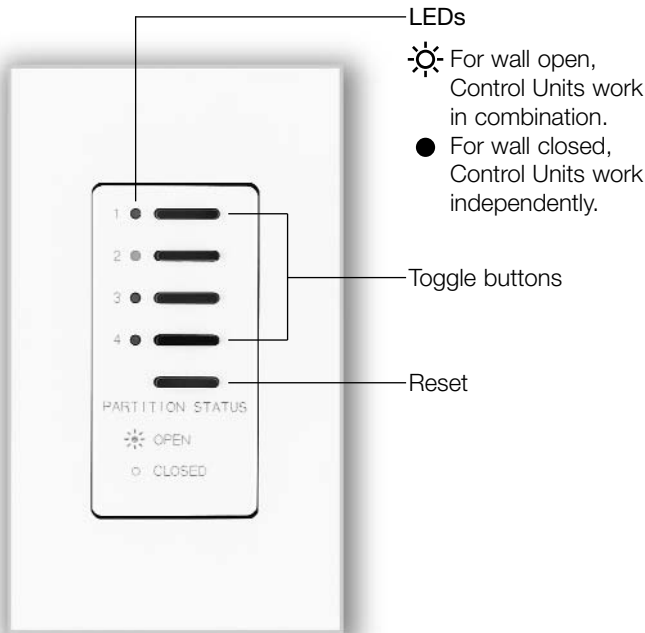

Example

Button:	Wall:	Combine Control Units:
Button 1	Wall 1	A and B
Button 2	Wall 2	B and C
Button 3	Wall 3	C and D
Button 4	Wall 4	D and E

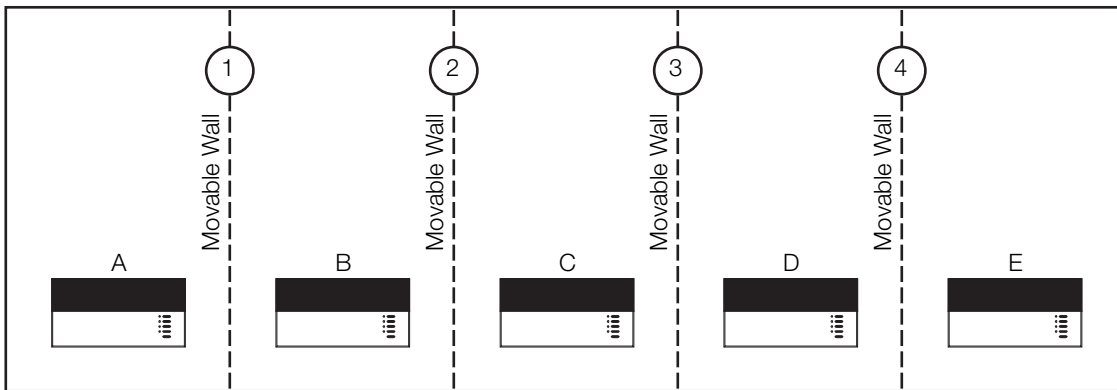

Job Name:	Model Numbers:
Job Number:	

Color and Finish Codes

NTGRX-4M-__-__
4-Button Master Wallstation

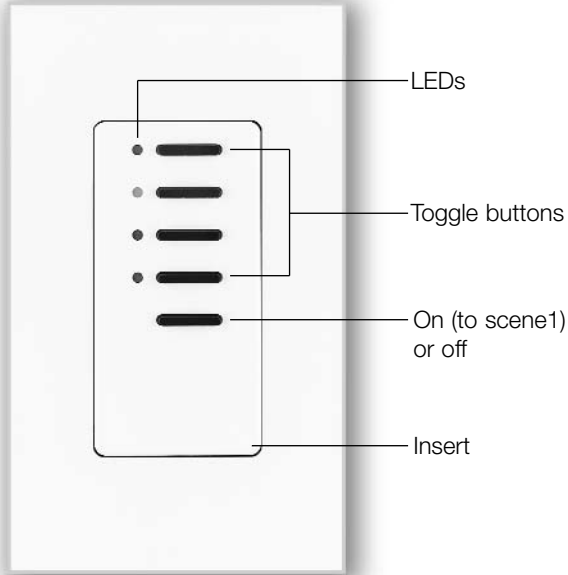



Description

- Allows user to control several different areas of GRAFIK Eye lighting from one master location.
- Each button can operate a different GRAFIK Eye Control Unit or group of Control Units.
- Four buttons toggle their associated Control Units on (to Scene 1) and off.
- Status LEDs indicate which Control Units are on.
- The bottom button either turns all associated Control Units on (to scene 1) or off, depending on settings of DIP switches 5 and 6.
- In a home, a Master Wallstation might be placed inside the main entry. The first button would turn on foyer lights, the second button would light a path to the kitchen, etc.
- The Master Wallstation can work with a total of eight GRAFIK Eye 3000 or 4000 Series Control Units. The Control Units may be assigned to buttons in any combination.

Finish and Engraving Options

- Available with engraving to meet specific project needs.
- Available in a “no-insert” version for a sleeker look.

Field Selected Functionality

DIP Switch Settings	Bottom button:
5 6	
	Turns all associated Control Units on to Scene 1.
	Turns all associated Control Units off.

Job Name:	Model Numbers:
Job Number:	

Specifications

Power

Low-voltage type Class 2 (PELV).
Operating voltage: 12/24 V Direct Current.

Key Design Features

- Meets IEC 801-2. Tested to withstand 15kV electro-static discharge without damage or memory loss.
- Faceplate snaps on with no visible means of attachment.
- Can be ganged to share a common faceplate with NovaT* and Vareo Dimmers. Counts as a "small control" for ganging.

System Communications and Capacity

- Low-voltage type Class 2 (PELV) wiring connects Wallstations to Control Units and other components.
- Up to 8 Control Units and up to 16 total Wallstations and/or Control Interfaces may be linked for a total of 24 control points.

Terminals

Accept up to two #18 AWG (1.0mm²) typical.

Environment

32-104°F (0-40°C). Relative humidity less than 90% non-condensing.

Color and Finish Codes

Matte Finishes

Standard – Ship in 48 hours
White WH
Ivory IV
Beige BE
Gray GR
Brown BR
Black BL

Metal Finishes

Ship in 4 to 6 weeks
Bright Brass BB
Bright Chrome BC
Bright Nickel BN
Satin Brass SB
Satin Chrome SC
Satin Nickel SN
Antique Brass QB
Antique Bronze QZ

Anodized Aluminum Finishes

Ship in 4 to 6 weeks
Clear CLA
Black BLA
Brass BRA
Engraving E
No Insert NI

Also available:
-Custom Controls
-Color Matching
Ship in 4 to 6 weeks. Pricing may vary depending on finishes.

Dimensions Front View

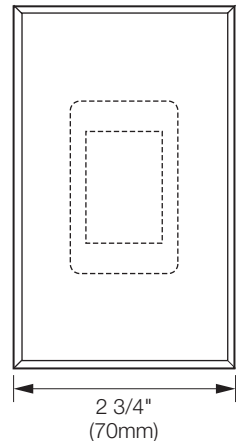

Side View

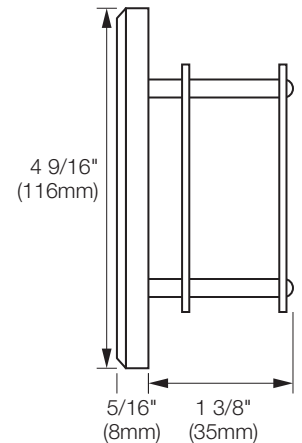

Mounting

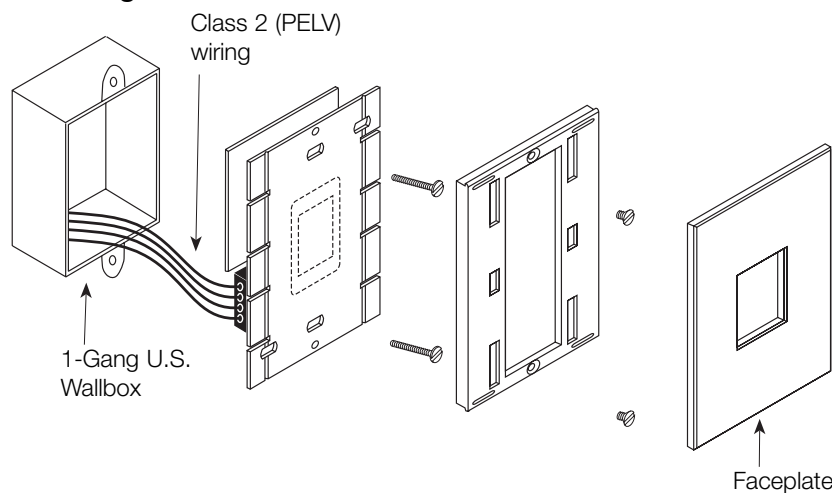

Back View

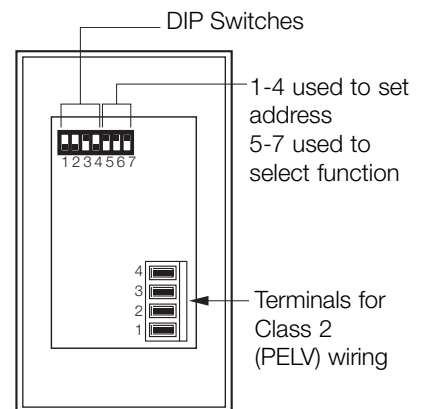

Job Name:

Model Numbers:

Job Number:

Wallstation Installation

DIP Switches

- Set DIP switches 1-4 to give the Wallstation a unique system address from 1 to 16.
- Set additional DIP switches (if any) to specify function as shown on the first page of the Wallstation's Specification Submittal.

Address	DIP Switch Settings			
	1	2	3	4
1				
2				
3				
4				
5				
6				
7				
8				
9				
10				
11				
12				
13				
14				
15				
16				

Reserved for GRX-PRG, if present on link.

Low-Voltage Class 2 (PELV) Wiring

- Use low-voltage Class 2 (PELV) wiring to daisy-chain Wallstations to Control Units and other components.
- Make connections inside the wallbox or in a switch/junction box with a maximum wire length of 8 feet (2.5m) from the link to the Wallstation.

Note: EGRX Wallstations have a "D" terminal for Drain. Connect the Drain/Shield at this terminal.

When used with GRAFIK Eye 3000 Control Units:

- Two #18 AWG (1.0mm²) conductors for common (terminal 1) and 12 V Direct Current (terminal 2). Ensure that the terminal 2 connection is wired correctly. Refer to GRX-3000 Specification Submittal.
- One shielded, twisted pair #18 AWG (1.0mm²) for data link (terminals 3 and 4).

When used with GRAFIK Eye 4000 Control Units:

- Two #12 AWG (2.5mm²) conductors for common (terminal 1) and 24 V Direct Current (terminal 2). These won't fit in terminals. Connect as shown.
- One shielded, twisted pair #18 AWG (1.0mm²) for data link (terminals 3 and 4).
- Connect Drain/Shield as shown. Do not connect to Ground (Earth) or Wallstation. Connect the bare drain wires and cut off the outside shield.

Wallstation Rear View

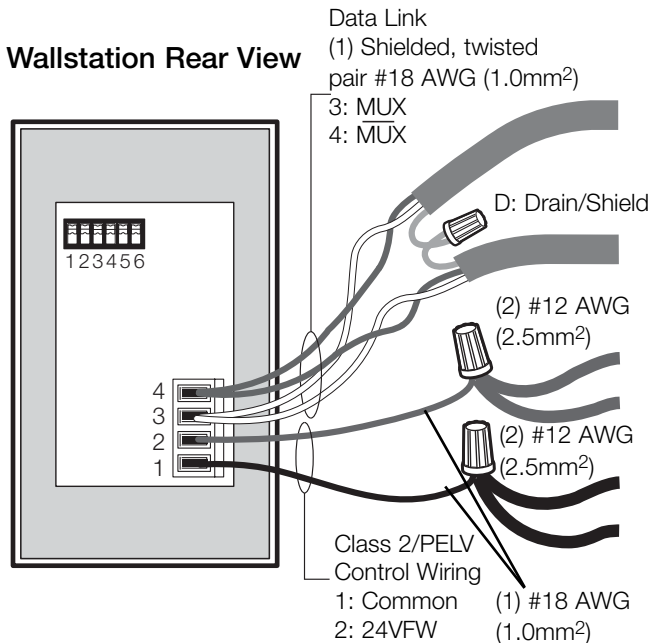

Job Name:	Model Numbers:
Job Number:	